

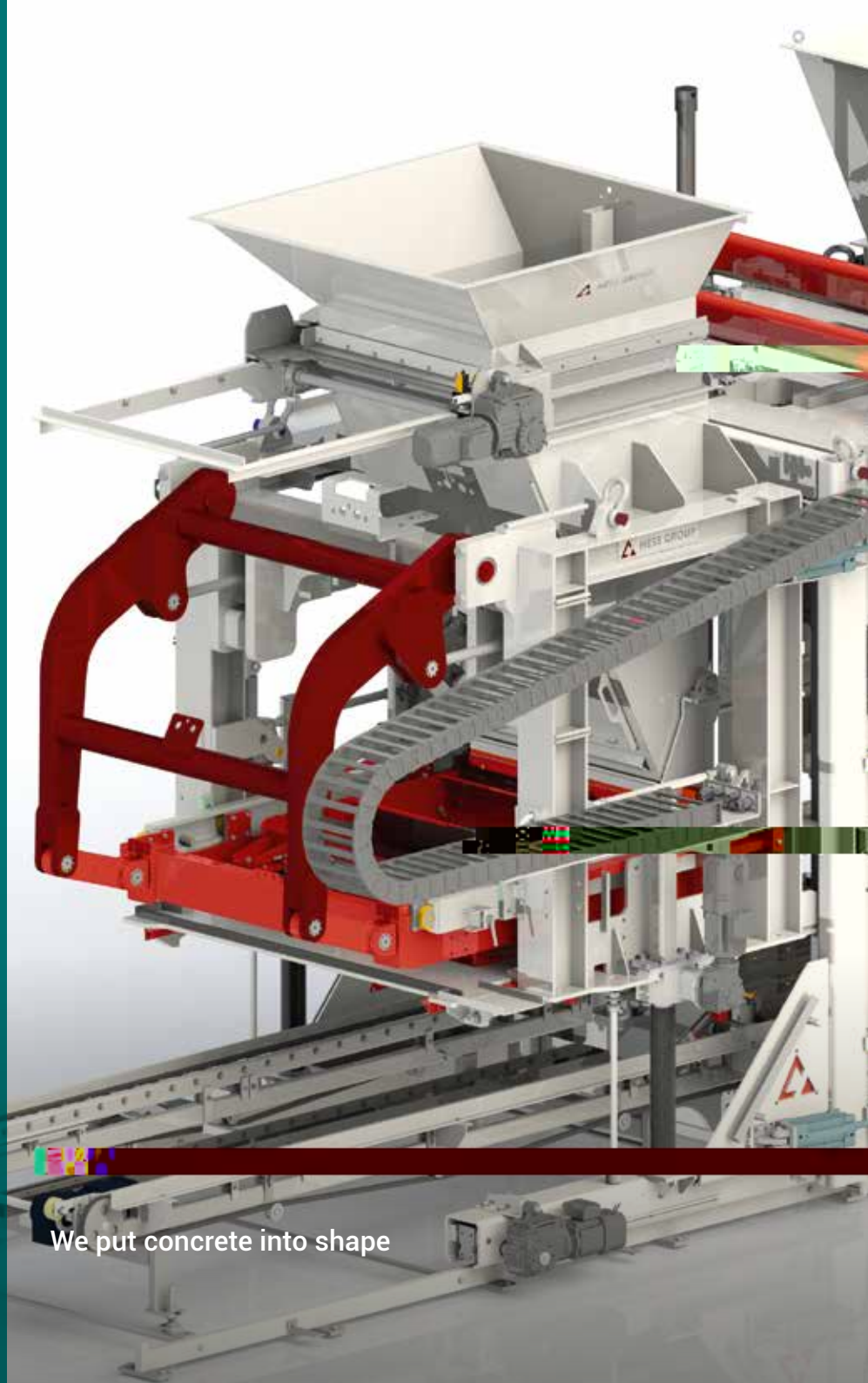

HESS GROUP



We put concrete into shape



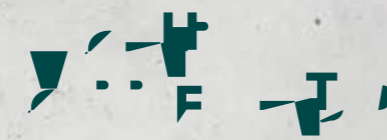
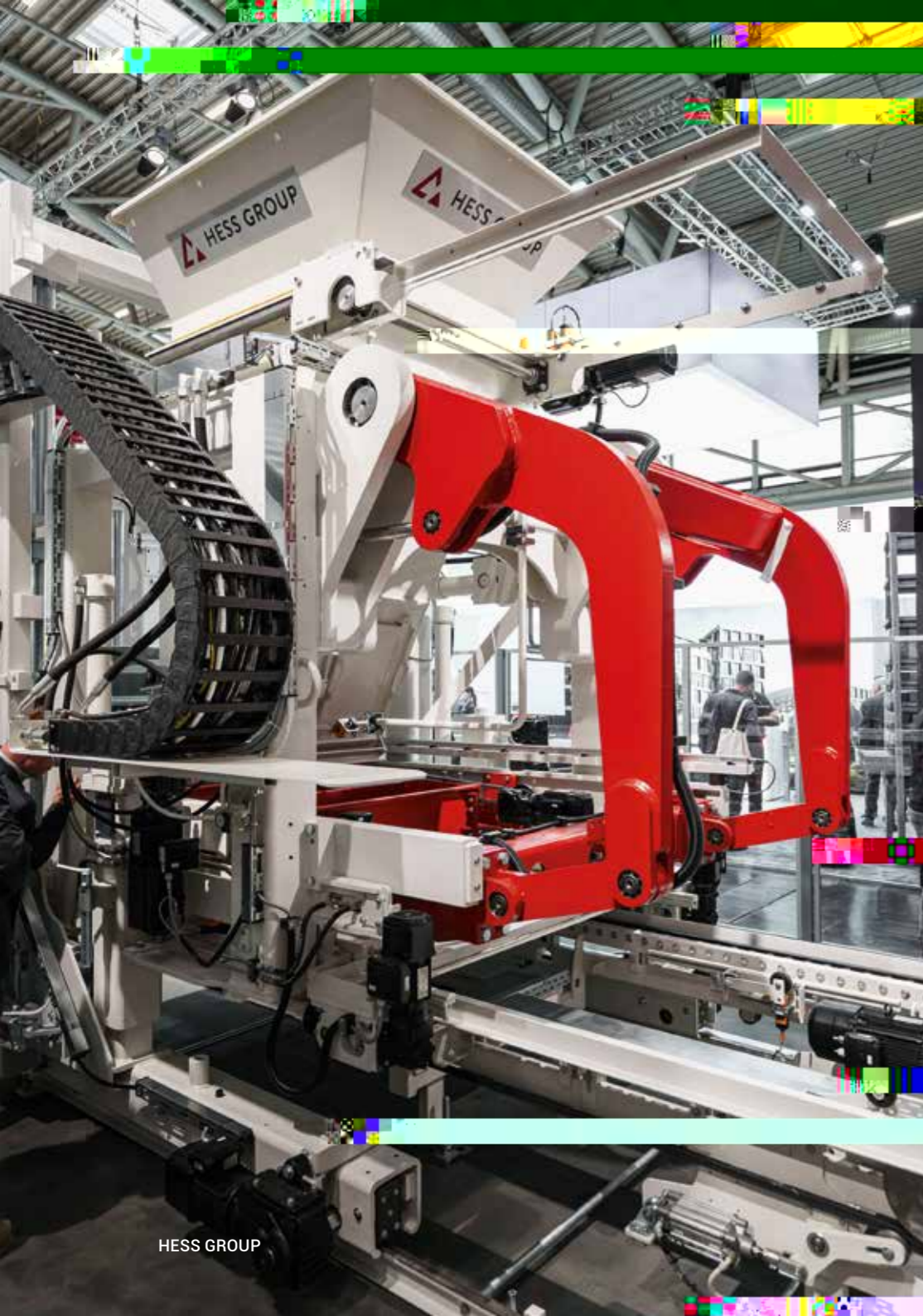

As an innovative manufacturer of high-quality concrete block and paver plants, we – together with our customers – ensure our mutual market leadership.



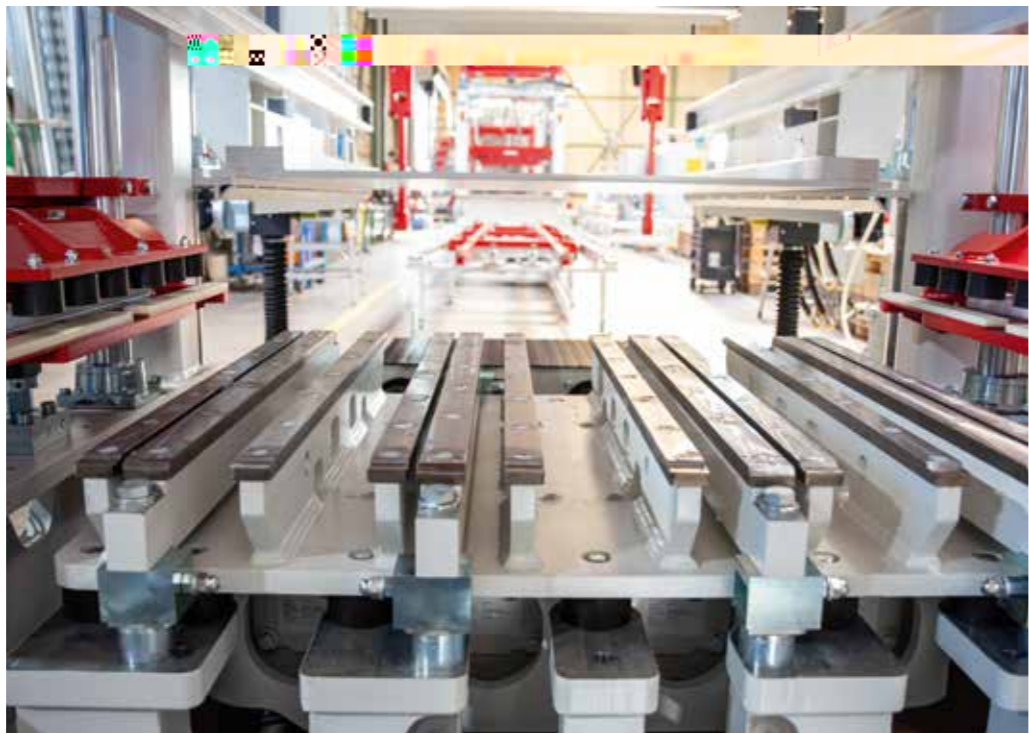
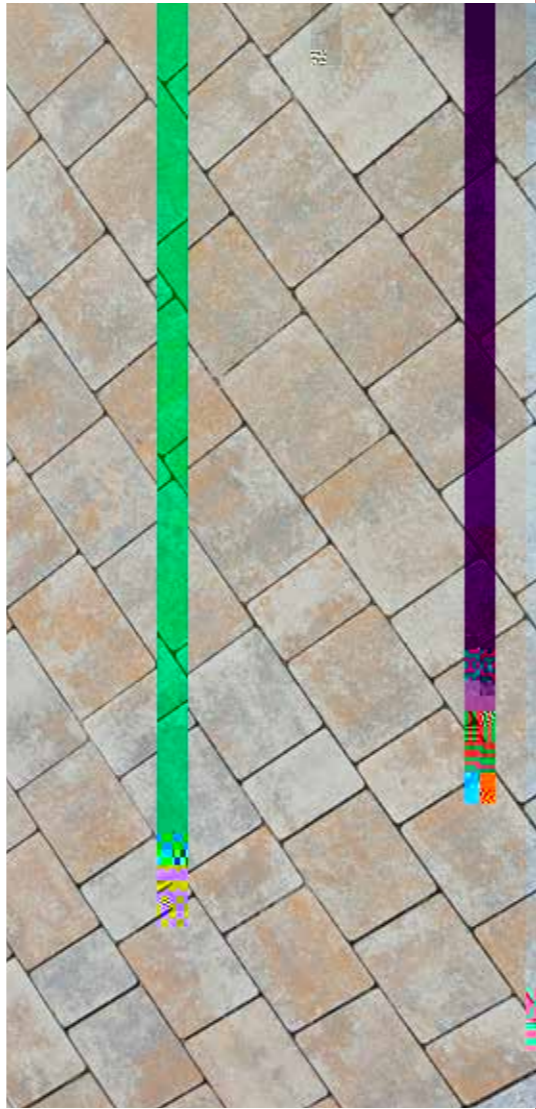
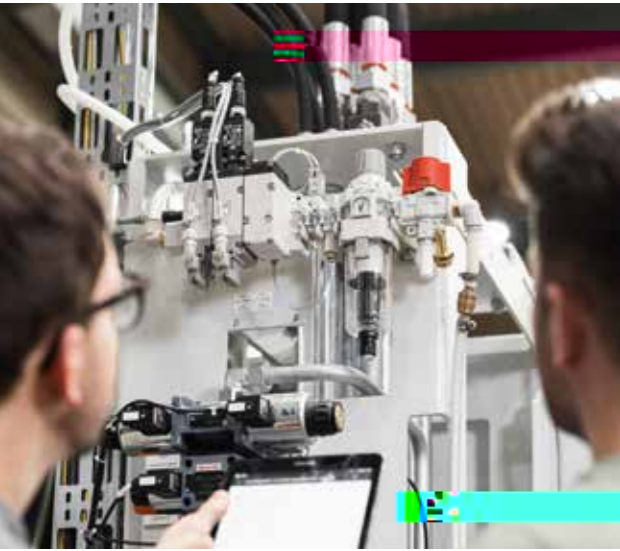

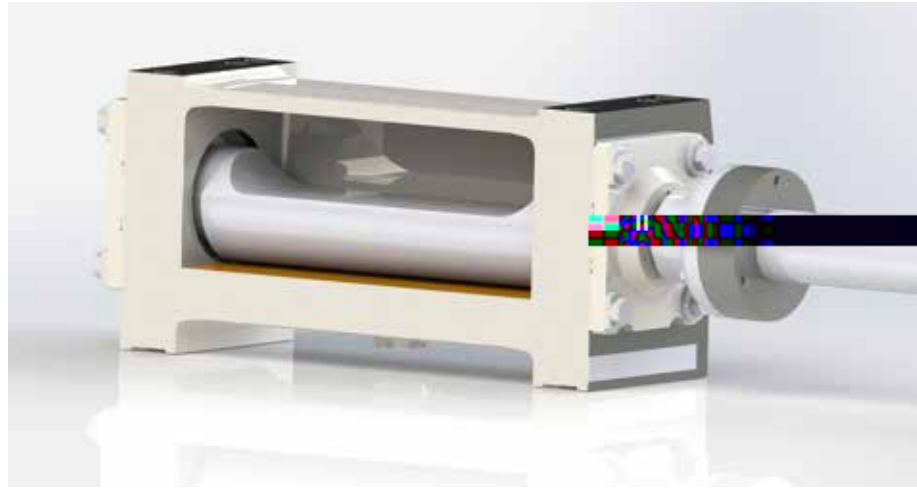

Model oil bath vibrator



Colormix device with draw plate

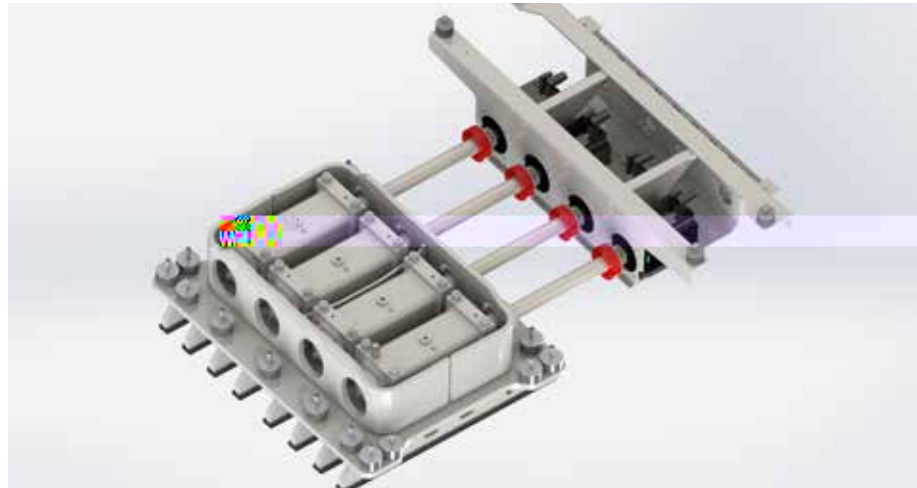

VarioTronic vibrating table, view from below

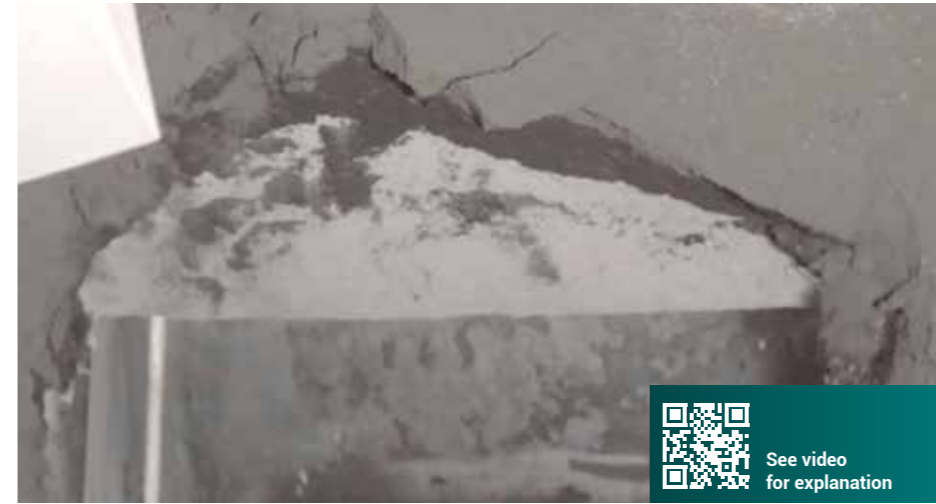
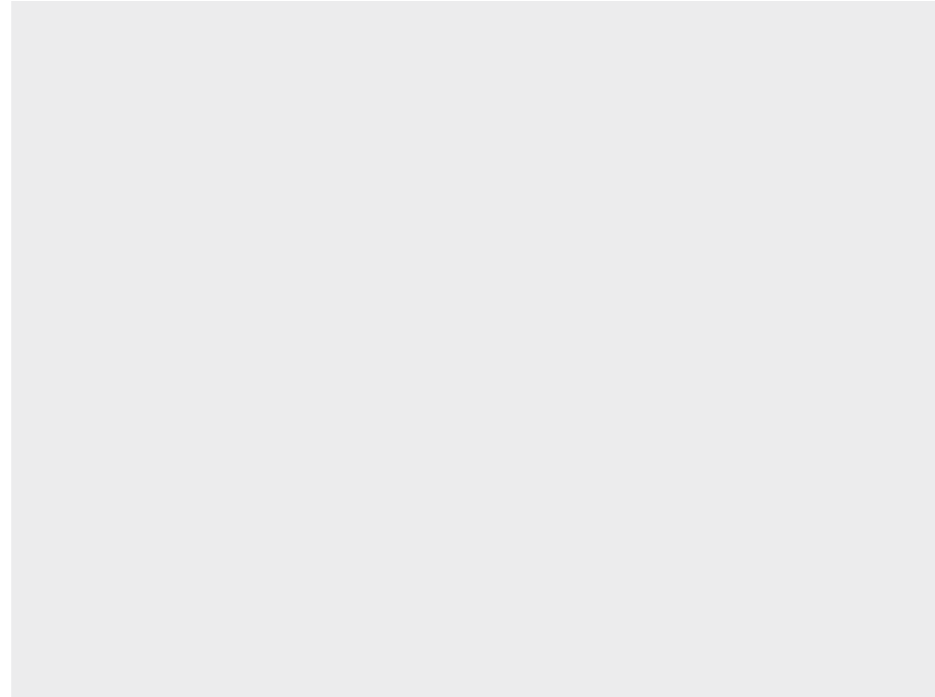

Colormix device with two layers of colored concrete

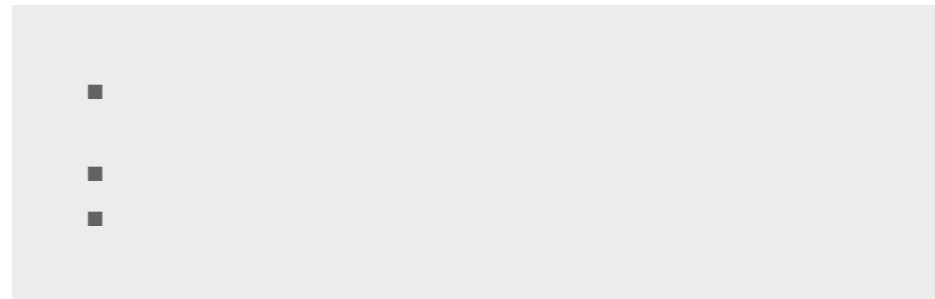

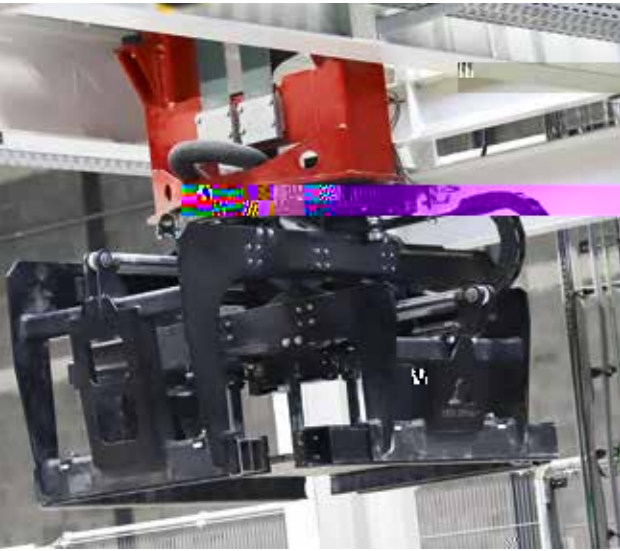



Interior view of mixer with raw materials

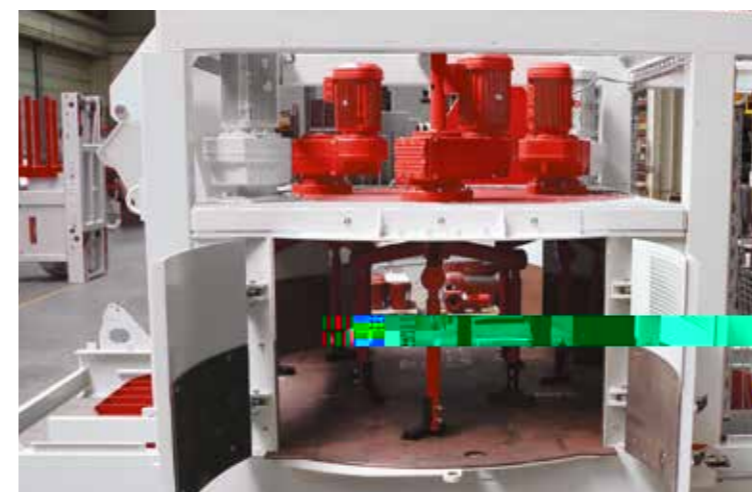

Interior view of base mix mixer



Color-Mix shuttle belt system

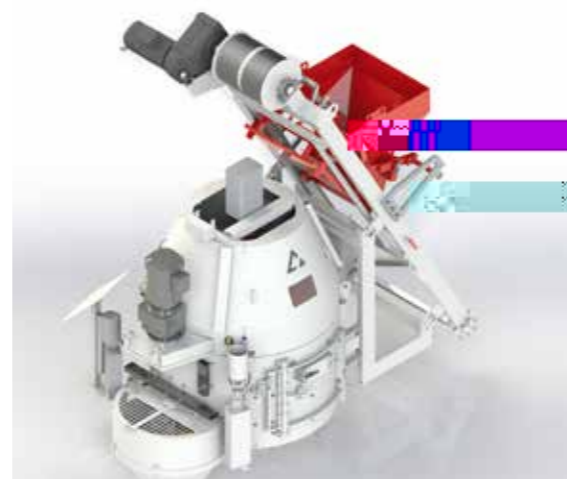

Face concrete mixer SM 500

TECHNICAL OVERVIEW OF BATCHING AND MIXING PLANTS

	SM 500	SM 1500	SM 2250	SM 3375	SM 4500

-
-
-
-
-
-
-
-



Color-Mix Product

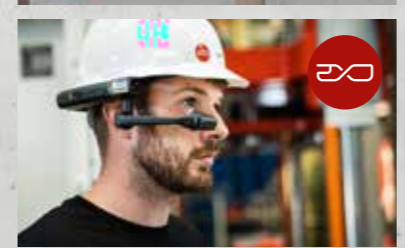



HESS Group GmbH

We put concrete into shape